

1917 flown by
 Hpt. Eduard Ritter von Scheleich,
 C.O. of Jasta 21

DV **Albatros**

AUSTER Antartic

1999 by F.Prudenziati

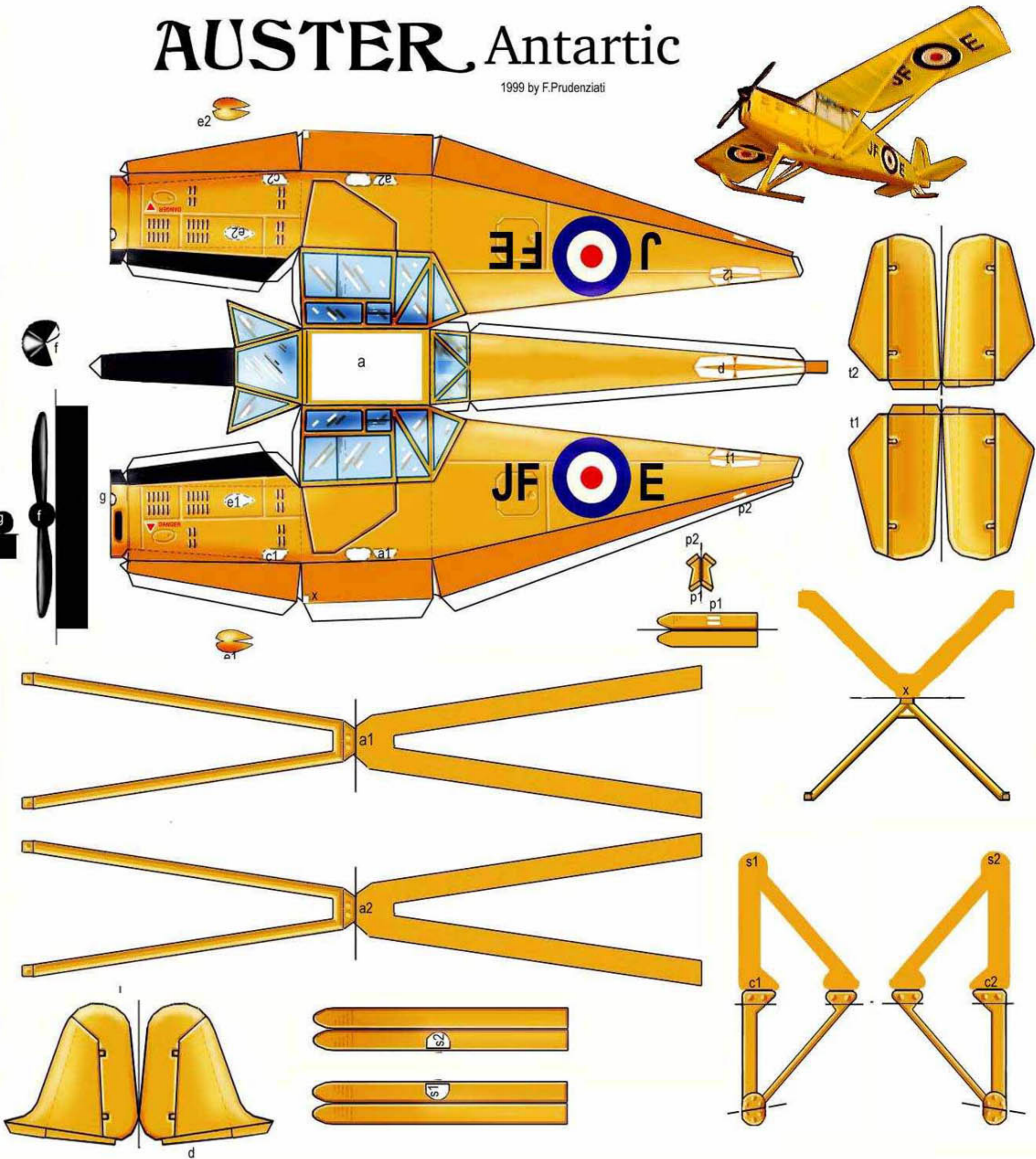
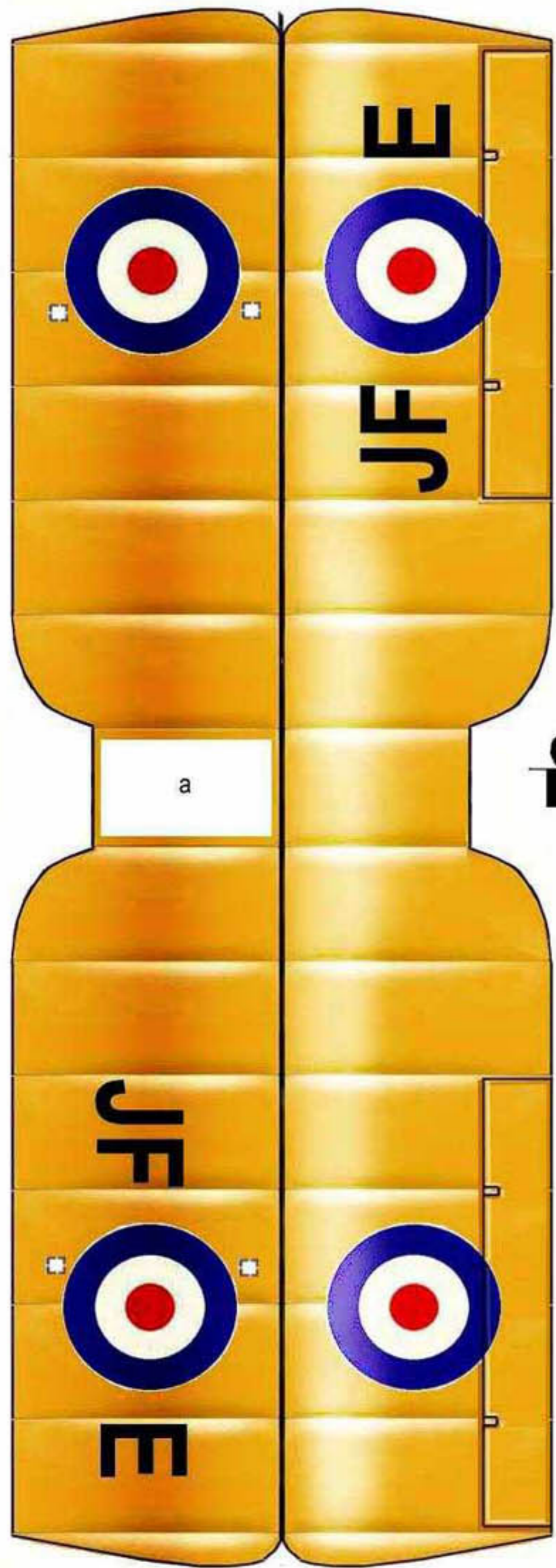

Jokker d VII

© 2000 by F. Prudenziati

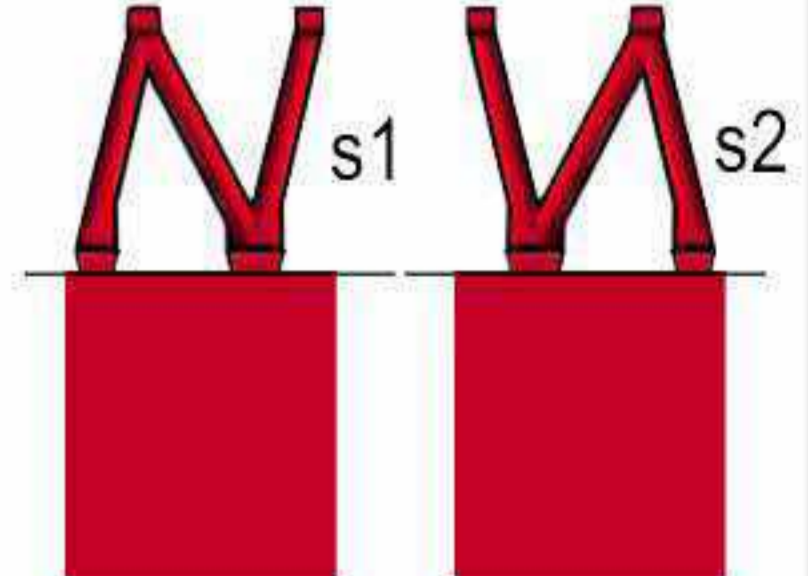
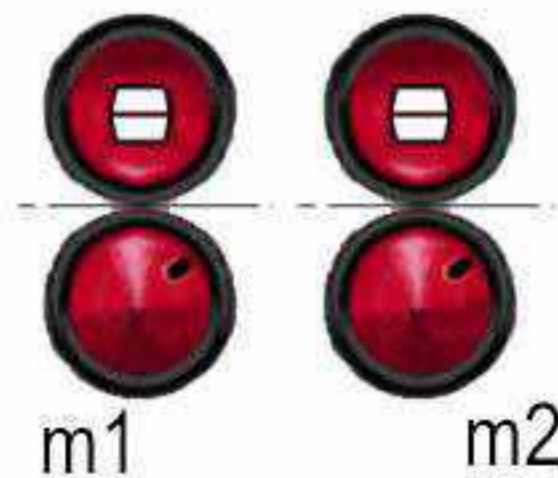
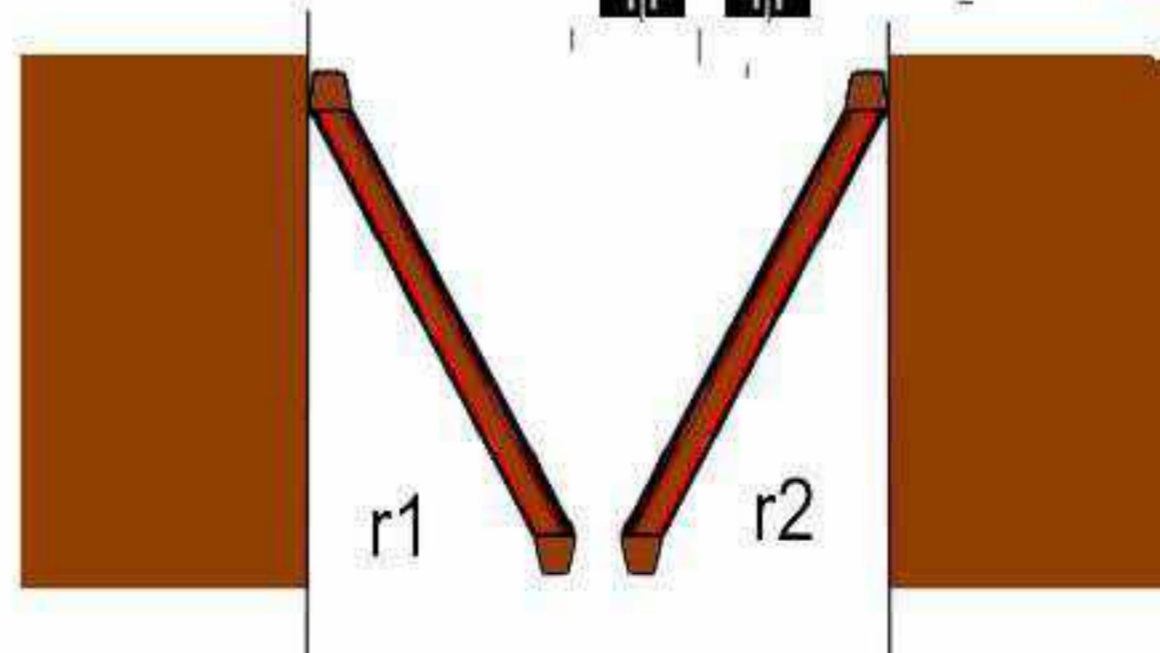
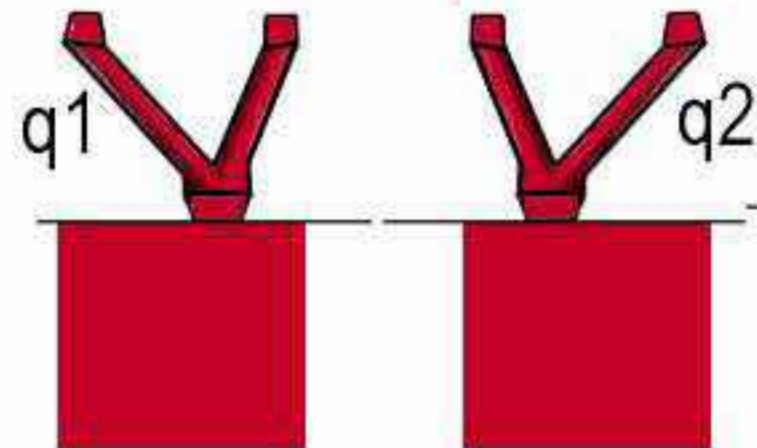
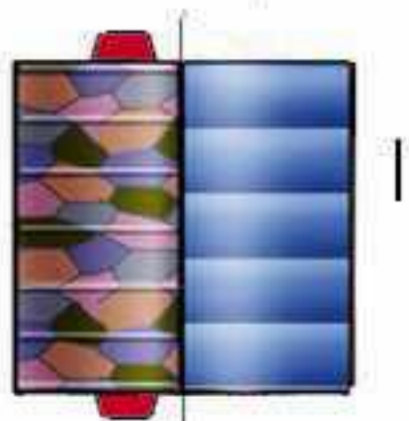
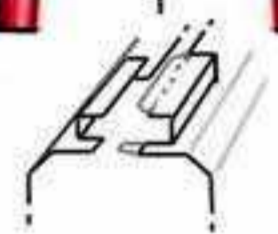
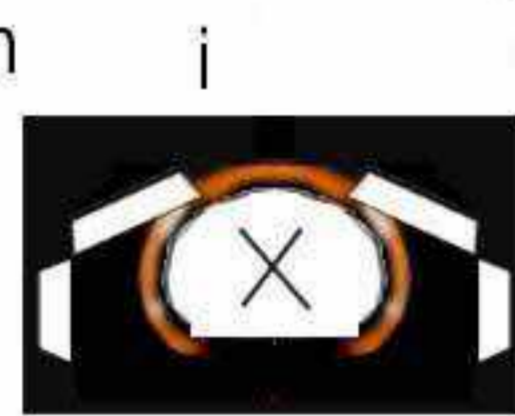
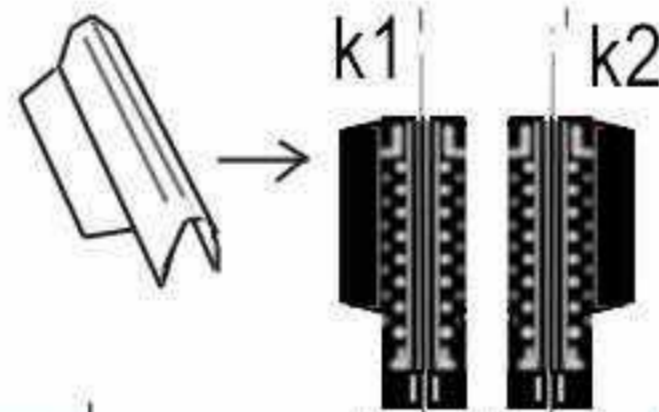
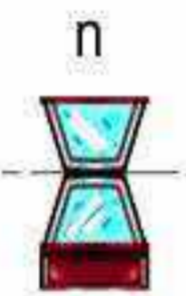
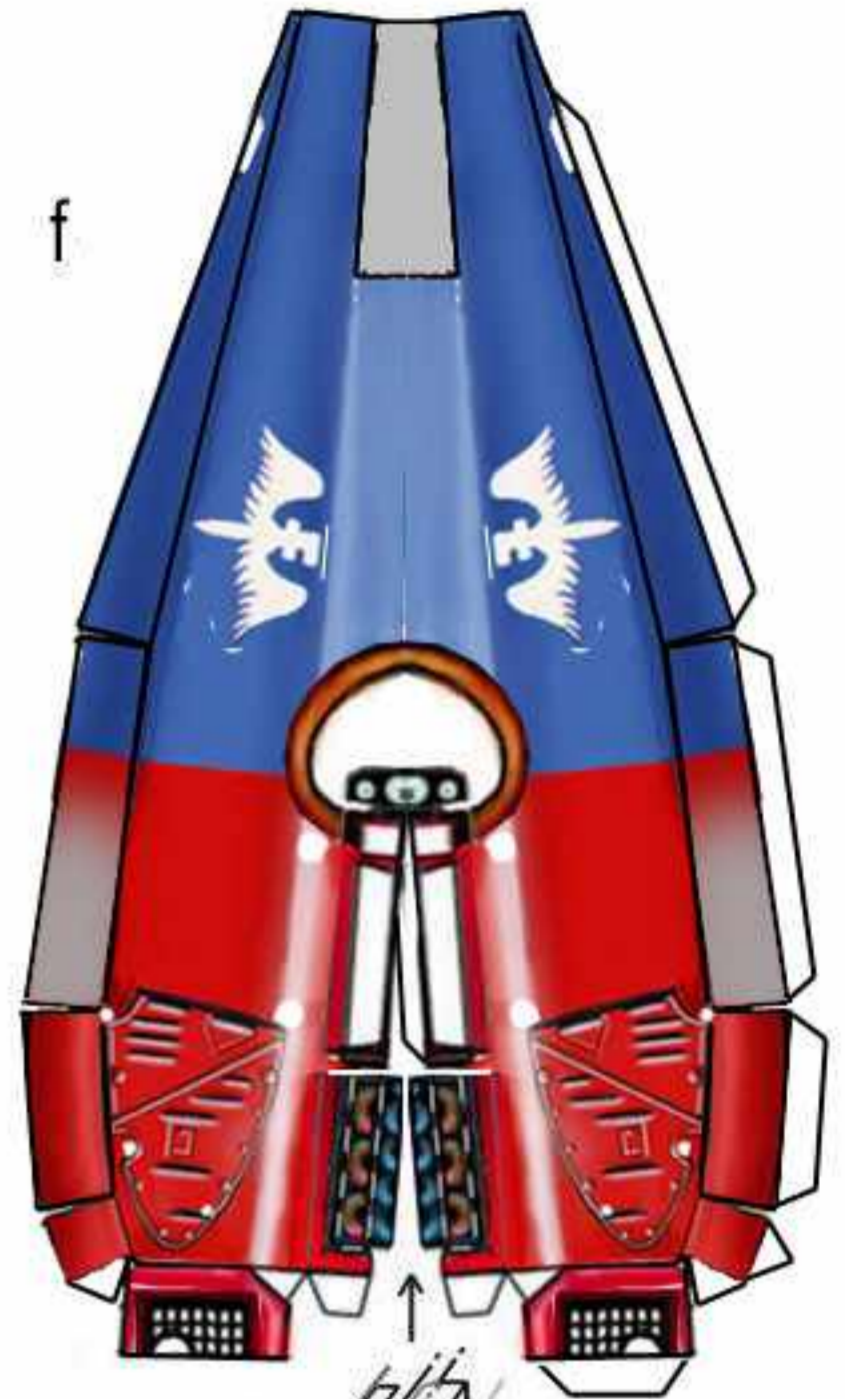
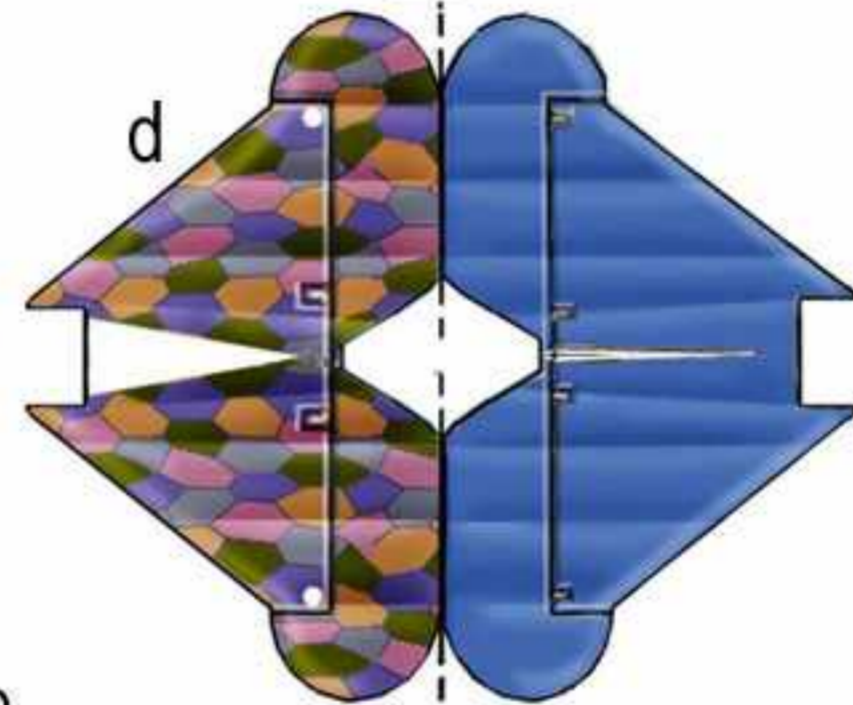
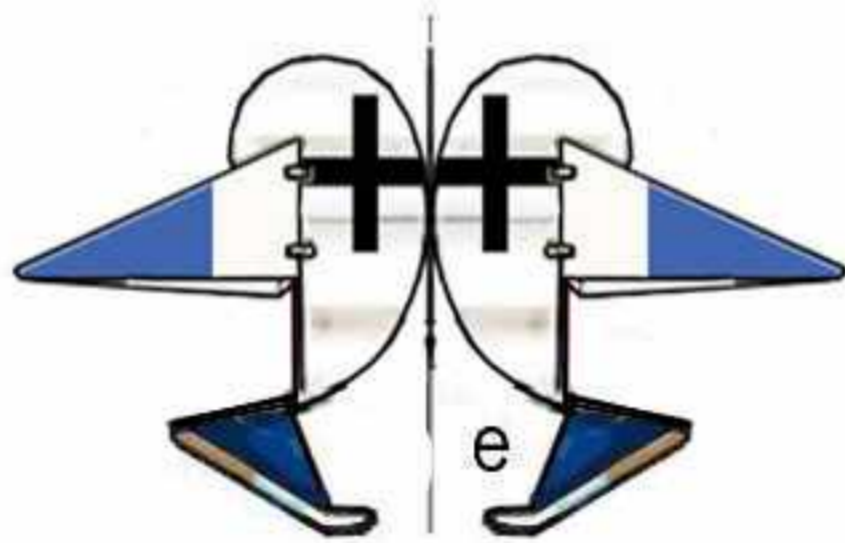
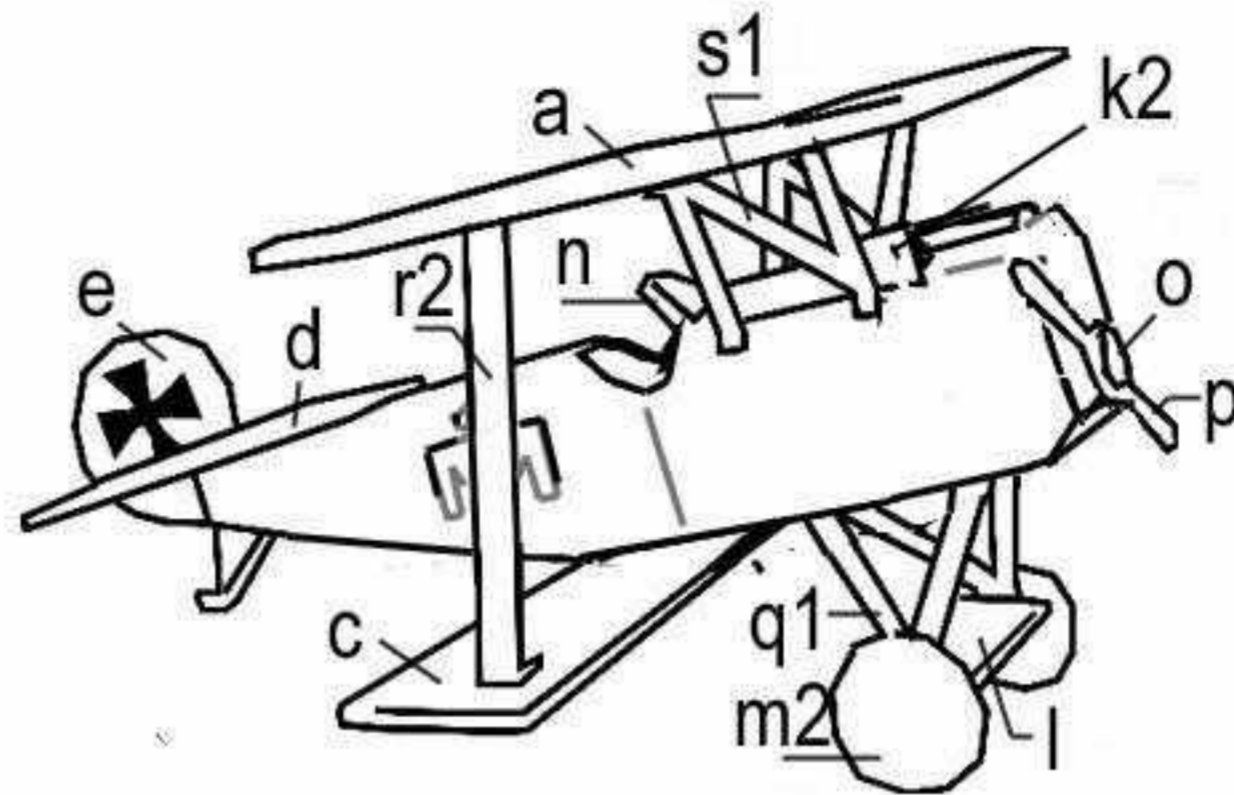
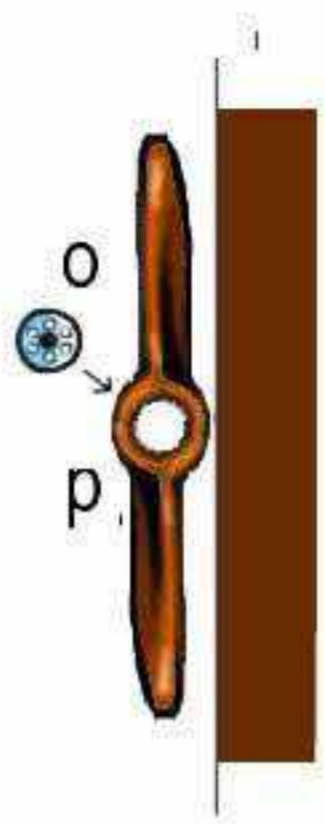
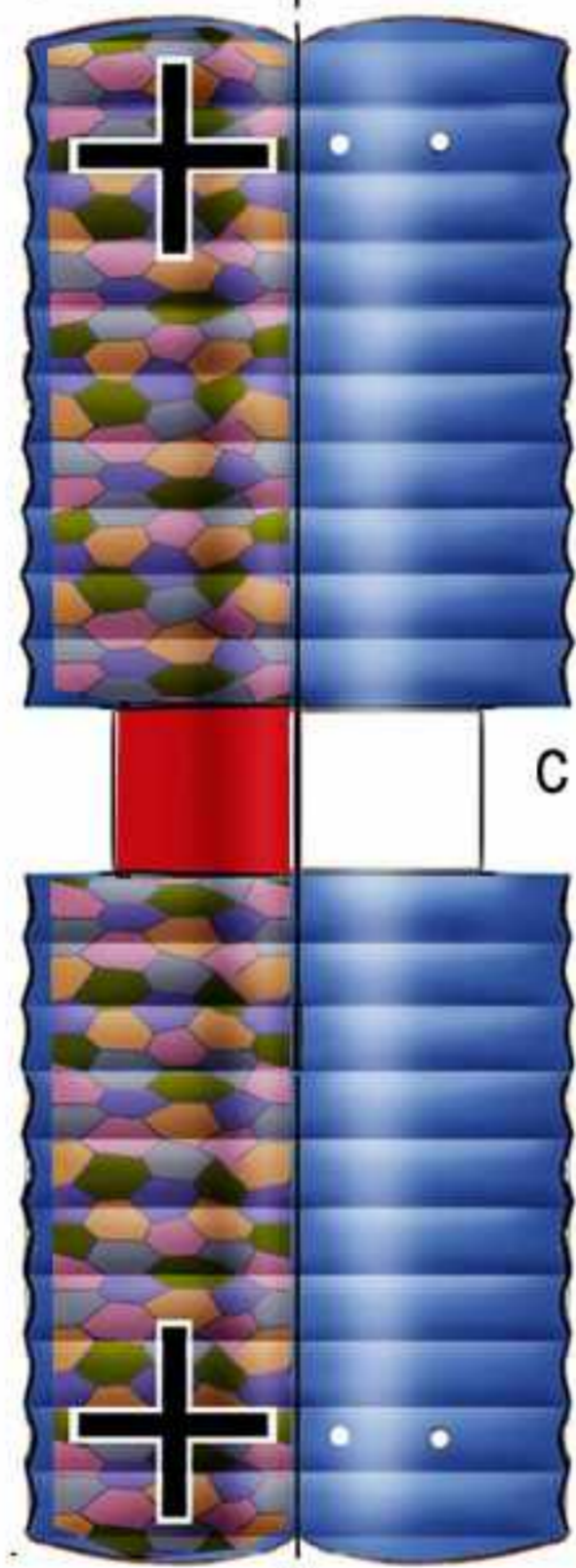
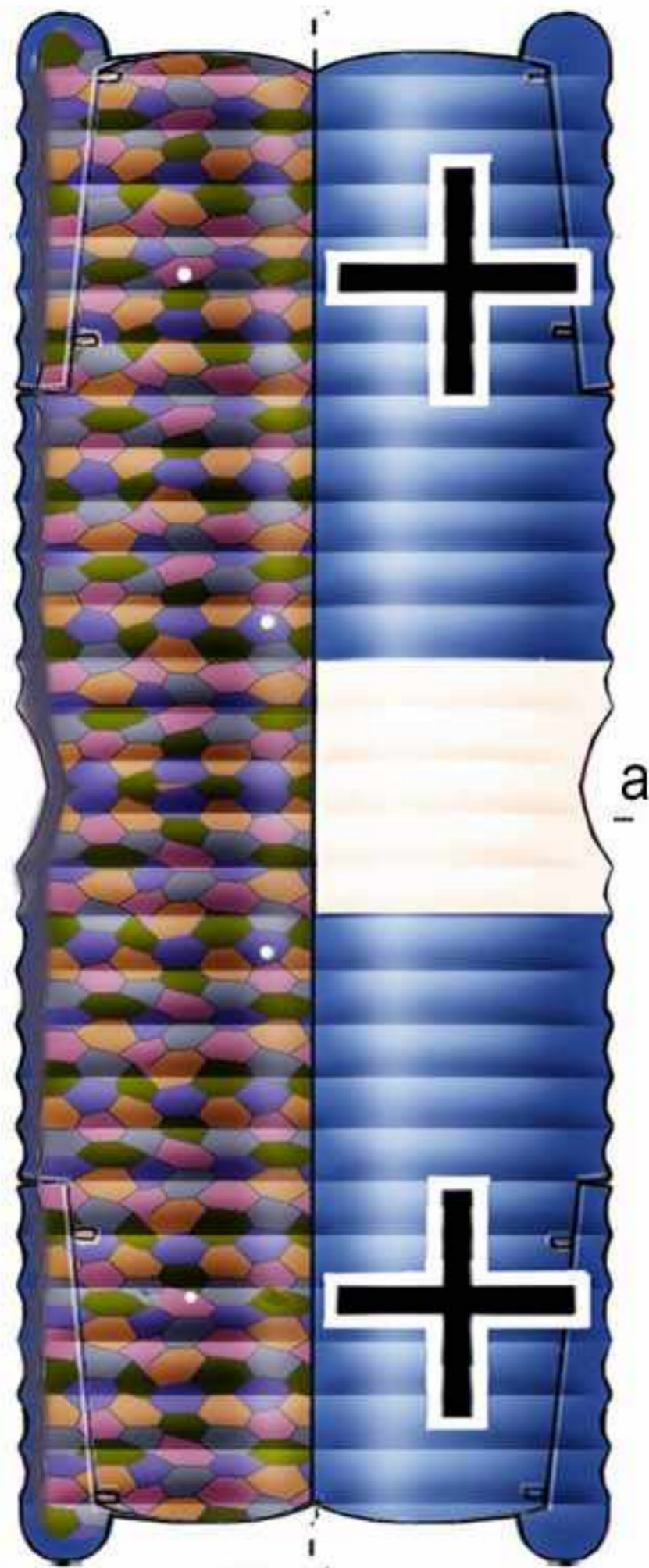

Fokker dr1 Triplane

1981-99 by F. Prudenziati

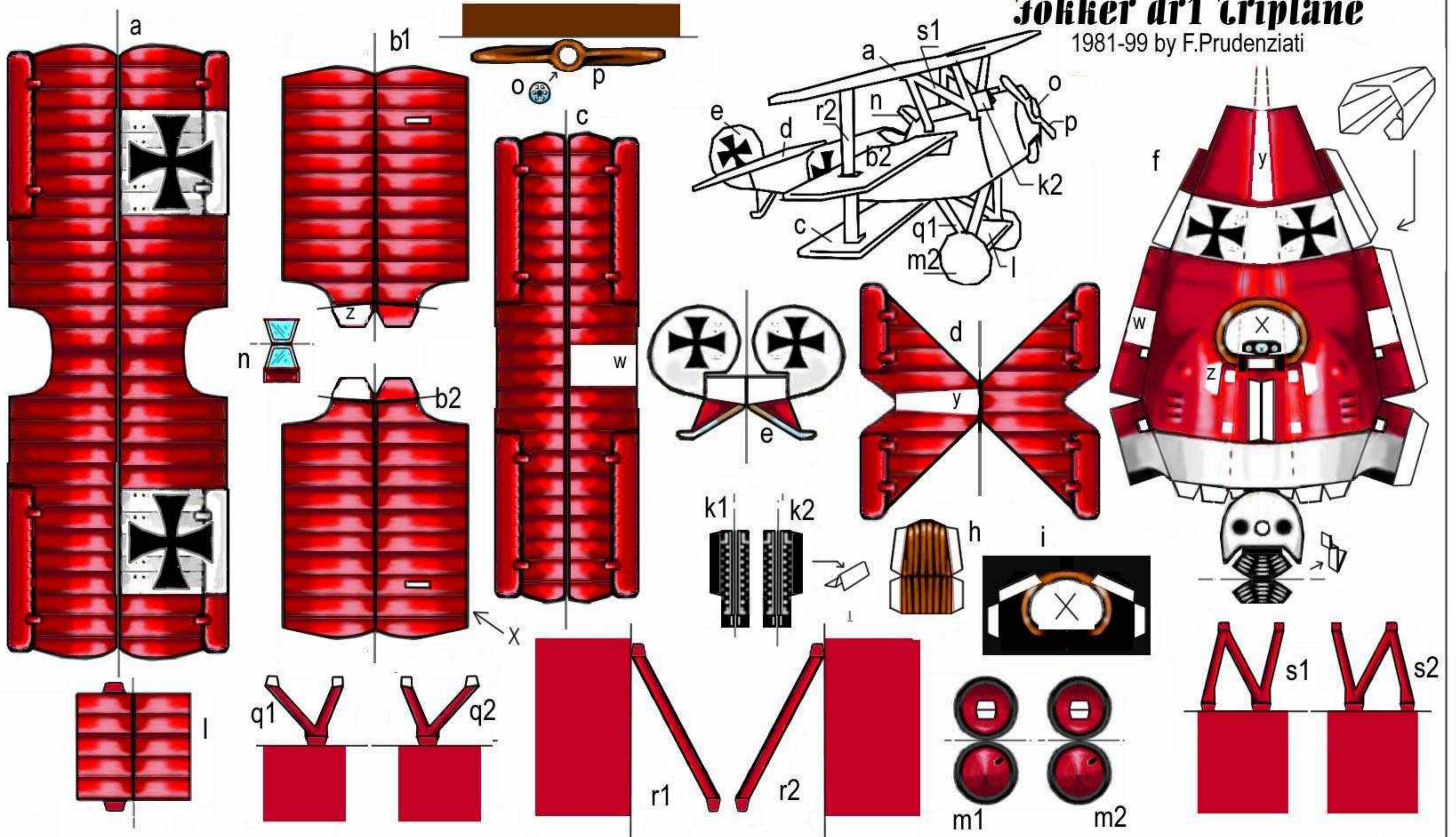

se ne consiglia la stampa con CorelDraw su carta patinata da 100./150 gr