

# RQ-7 UAV

United States ARMY

1:12 Scale

2013 | 01

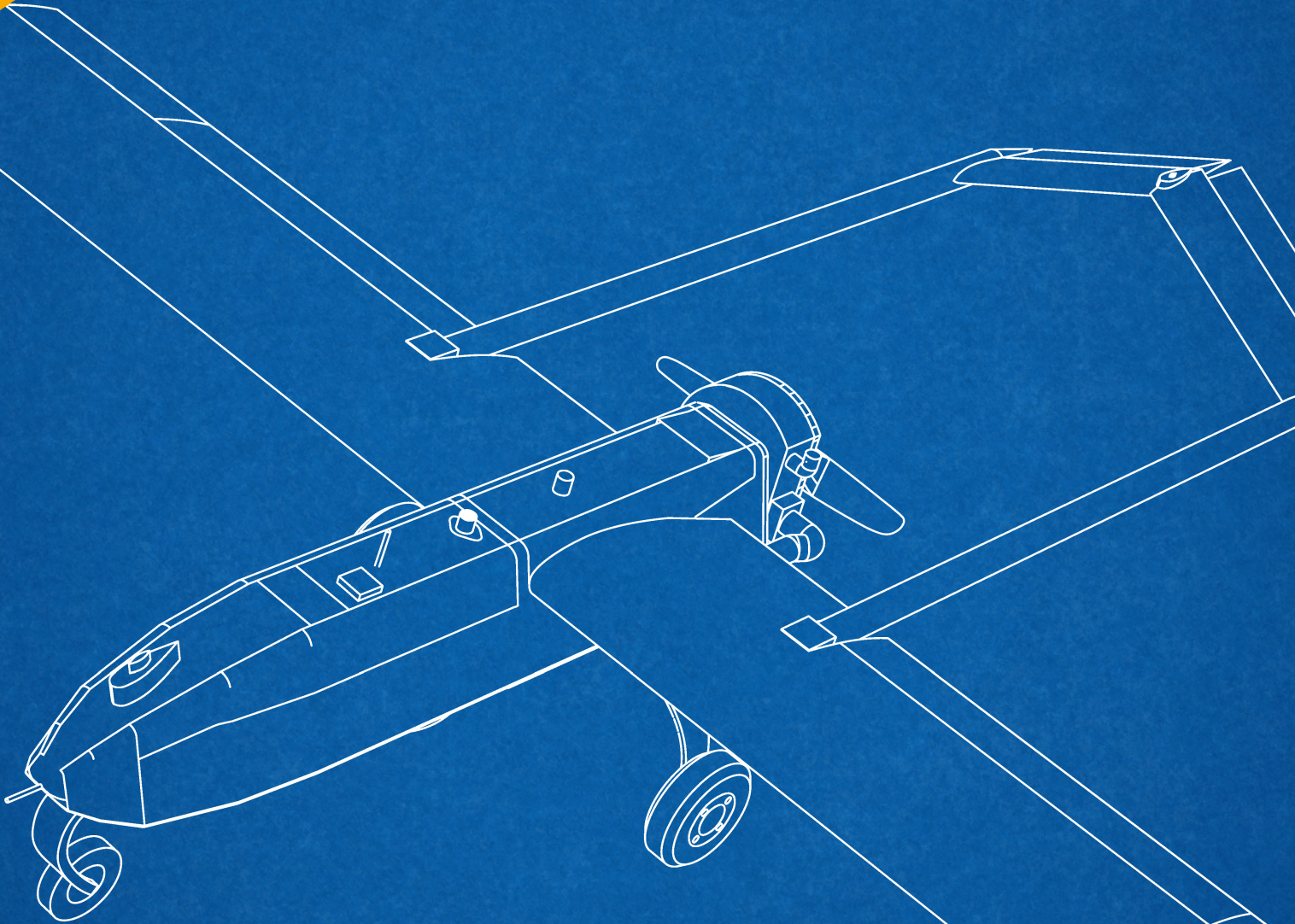

**DH** DAEHO  
Publishing

DAEHO PUBLISHING. ALL RIGHTS RESERVED. 2012 | [www.hardcraft.net](http://www.hardcraft.net) | Tel. +82-070-8250-0265 | Fax. +82-070-8250-0266 | e-mail [info@hardcraft.net](mailto:info@hardcraft.net)

★ 본 도면은 비상업용으로 배포되는 비매품 도면입니다. 상업적 이용시 반드시 DH Publishing과 상의하여야 하며 저작권은 DH Publishing 및 저작권자에게 있음을 명시합니다.



# RQ-7 UAV U.S.ARMY 1:12

## Assembly

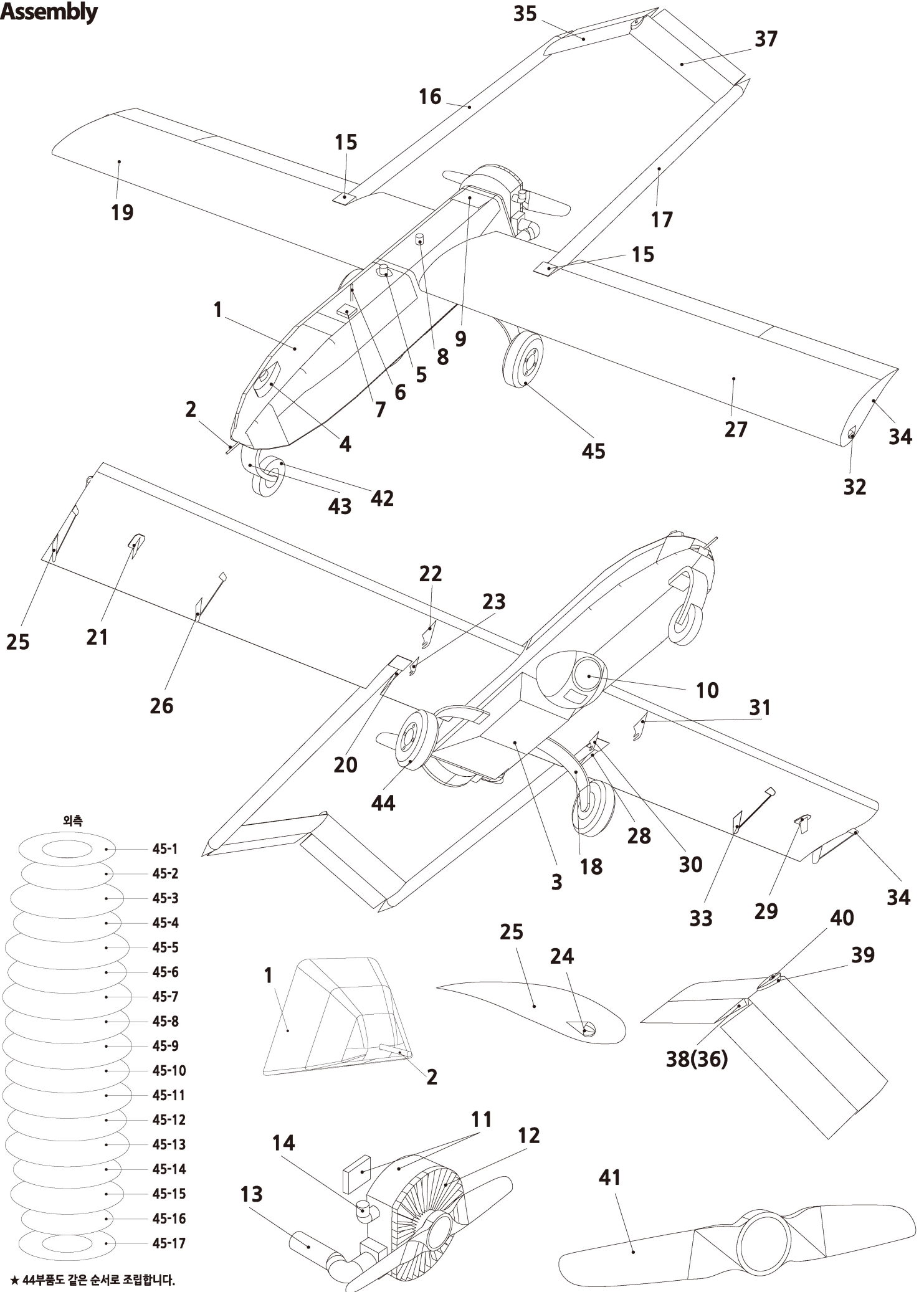



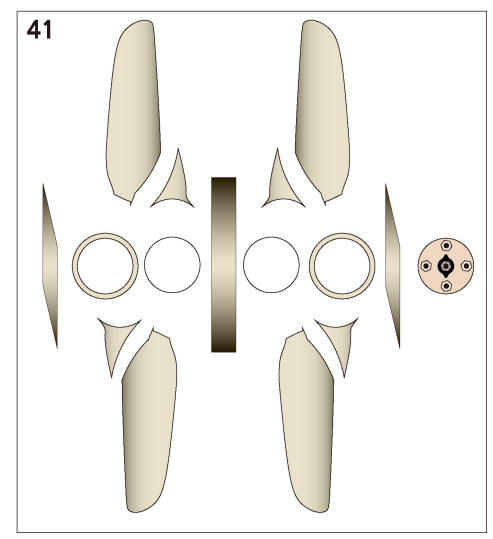
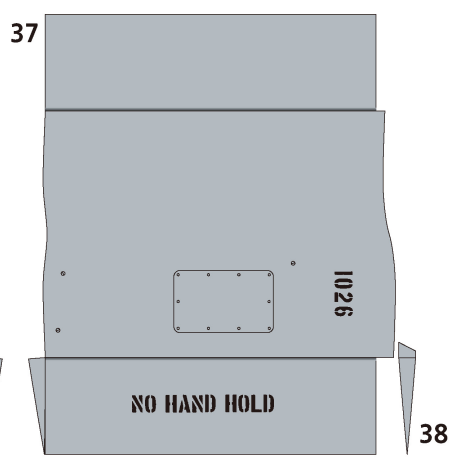
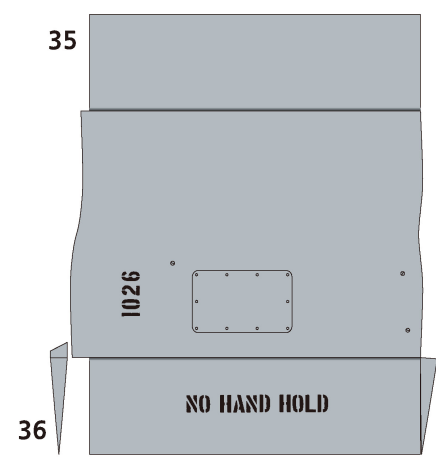
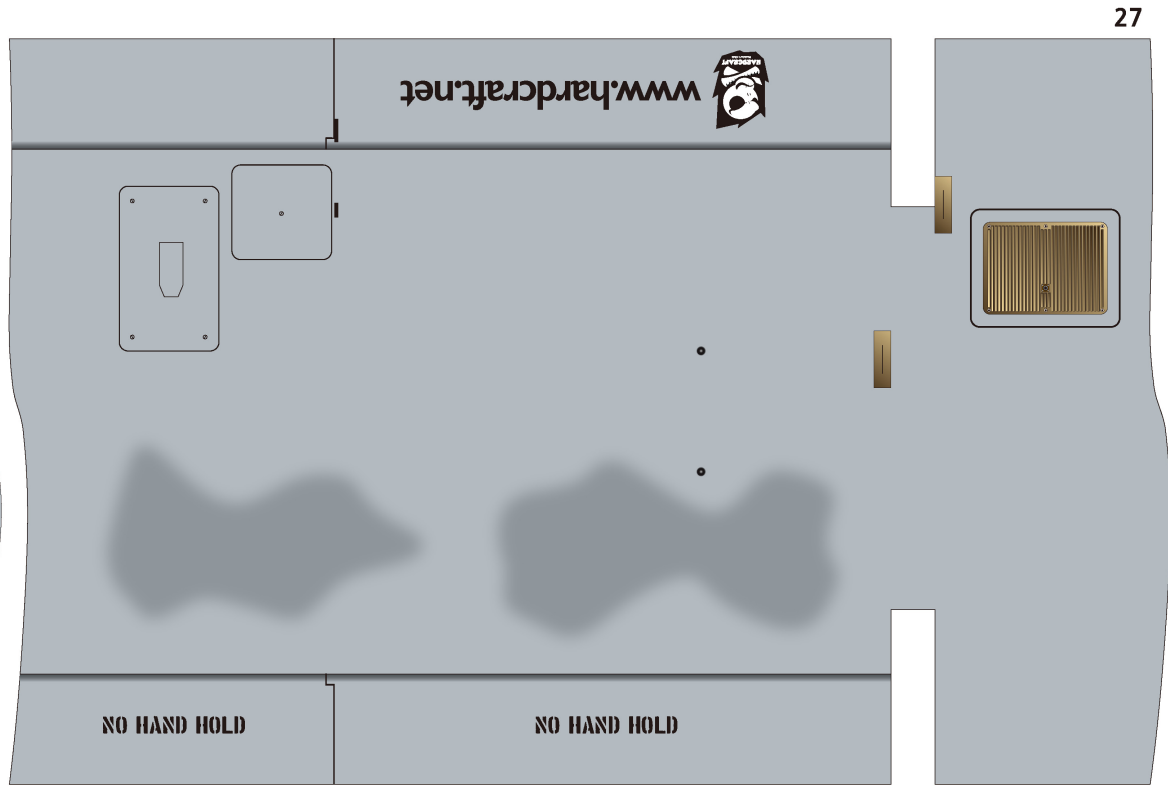
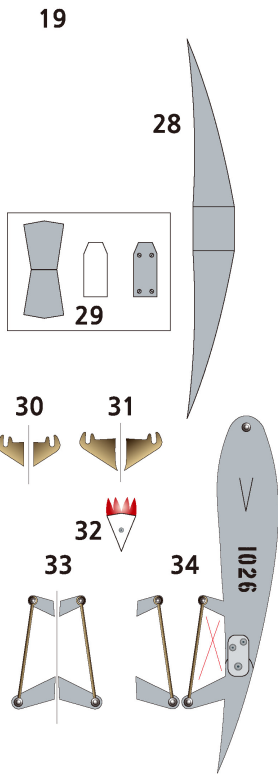
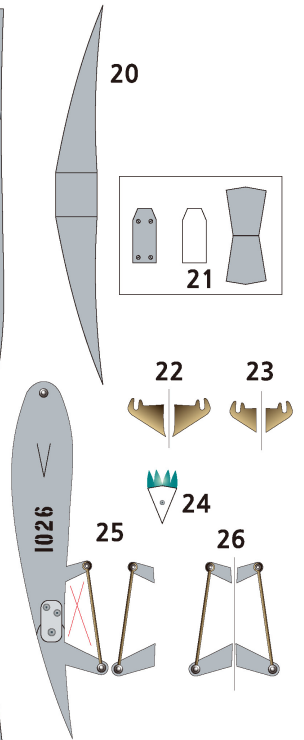
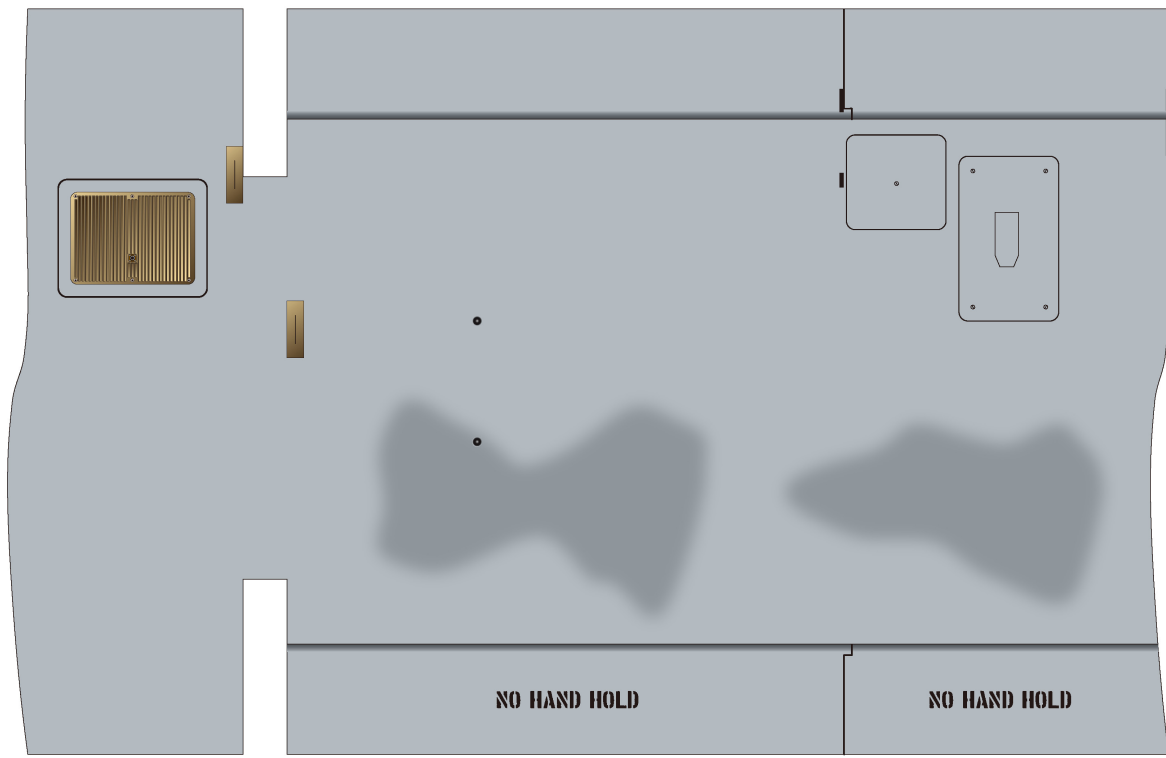





42

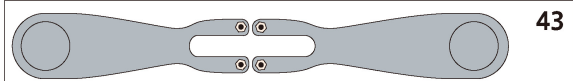

43

조립 참고 각도 및 두께

이 부품은 0.8mm 보드를 한 장만 합지하세요.

18

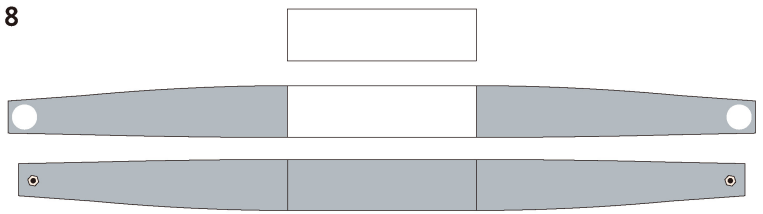

조립 참고 각도 및 두께  
이 부품은 0.8mm 보드를 한 장만 합지하세요.

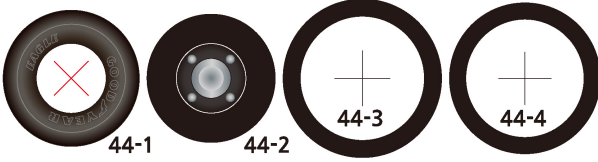

44-1

44-2

44-3

44-4

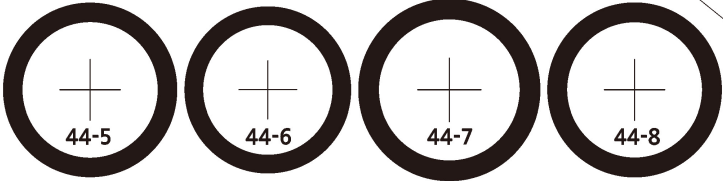

44-5

44-6

44-7

44-8

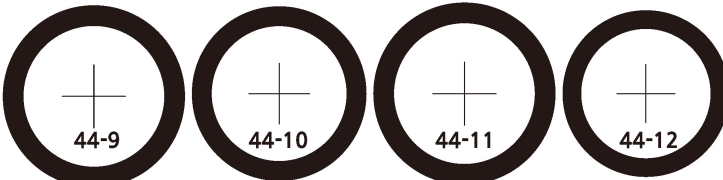

44-9

44-10

44-11

44-12

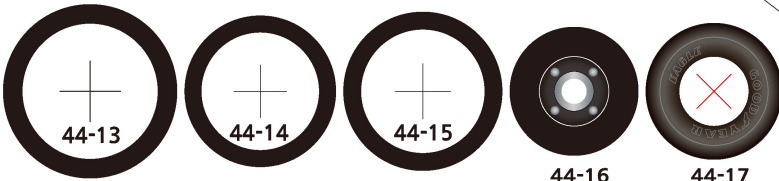

44-13

44-14

44-15

44-16

44-17

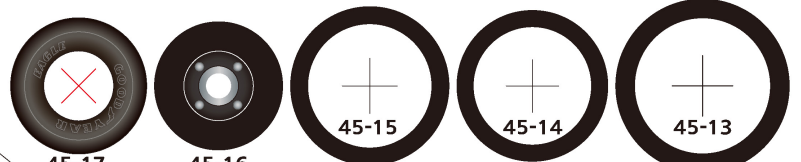

45-17

45-16

45-15

45-14

45-13

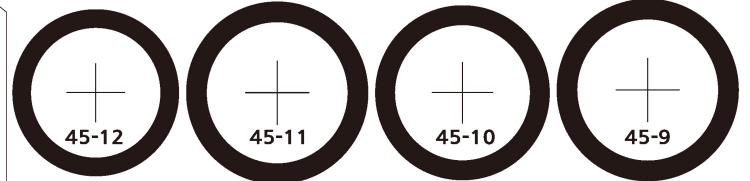

45-12

45-11

45-10

45-9

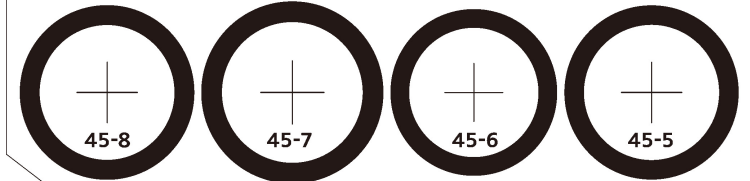

45-8

45-7

45-6

45-5



45-4

45-3

45-2

45-1

이 부품들은 0.8mm 보드를 합지하세요.

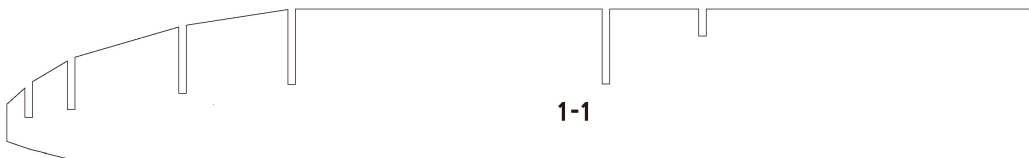

1-1

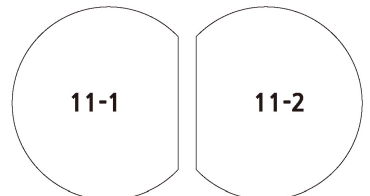

11-1

11-2

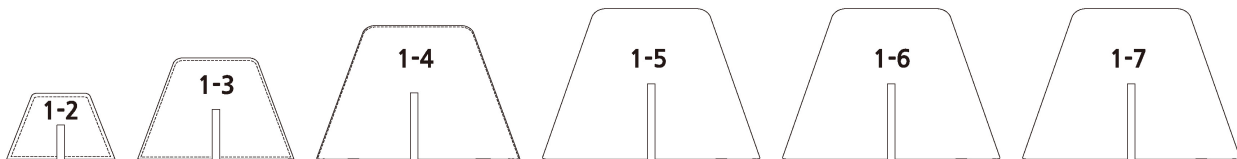

1-2

1-3

1-4

1-5

1-6

1-7

41-1

41-2



Body

19-1



1-8



Body

27-1



19-2

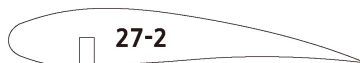

27-2

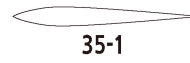

35-1



19-3

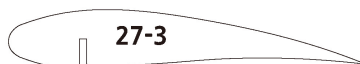

27-3

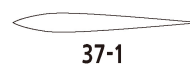

37-1



19-4



27-4

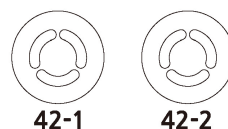

42-1

42-2

